

**Foot-switch**  
Series KFM1

Description **KFM1-SU2 SW**

Article number **6069100005**

**Operating symbol**

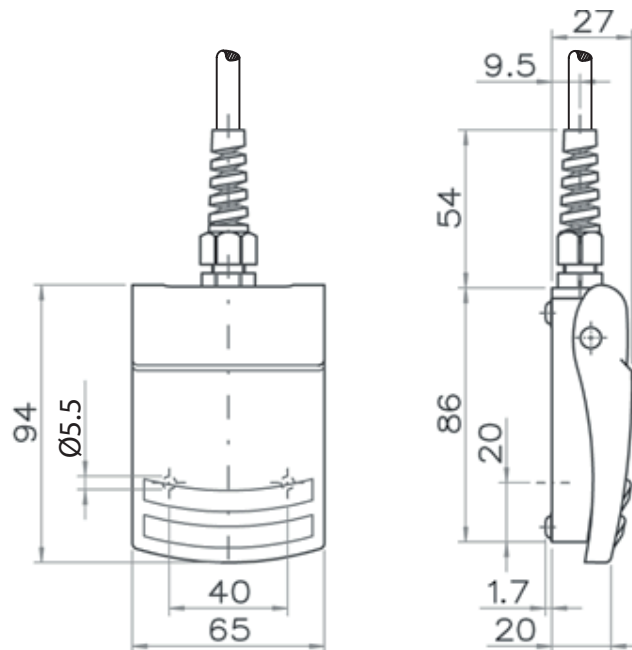
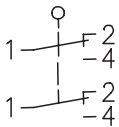

**Electrical data**

Rated operational current	$I_e$	4 A
Rated operational voltage	$U_e$	240 V AC
Protection class		II, fully insulated

Mechanical Data	
Enclosure	PA6.6 glass fibre reinforced, black-gray (RAL 7021)
Actuator	Foot lever PA6.6 glass fibre reinforced, black-gray (RAL 7021)
Ambient air temperature	-20 °C ... +80 °C
Contact type	2 changeover
Mechanical life	1 x 10 <sup>6</sup> switching cycles
Connection	PVC-control cable, composition corresponds to H05VV-F, S=0,5 mm <sup>2</sup> , black, length 2 m
Number of connections	6
Conductor cross-sections	0,5 mm <sup>2</sup>
Cable entry size	1 x cable gland M12 x 1,5 with bend protection
Protection type	IP 65 acc. to IEC/EN 60529

Standards
DIN EN 61058-1

EU Conformity
acc. to directive 2014/35/EU

Notes
The degree of protection (IP code) specified applies only to a properly closed cover.